



OFFICE OF STATEWIDE HEALTH PLANNING AND DEVELOPMENT  
FACILITIES DEVELOPMENT DIVISION

APPLICATION FOR OSHPD PREAPPROVAL  
OF MANUFACTURER'S CERTIFICATION (OPM)

OFFICE USE ONLY

APPLICATION #: OPM-0199-13

OSHPD Preapproval of Manufacturer's Certification (OPM)

Type:  New  Renewal  Update to Pre-CBC 2013 OPA Number: \_\_\_\_\_

Manufacturer Information

Manufacturer: Pentair Equipment Protection

Manufacturer's Technical Representative: Nate Westby

Mailing Address: 2100 Hoffman Way, Anoka, MN. 55303

Telephone: (763) 422-2660 Email: Nate.westby@pentair.com

Product Information

Product Name: 4-Post Rack

Product Type: Communication Equipment OPM-0199-13

Product Model Number: E4SDR19FM45U

General Description: Hoffman Pentair 4-Post open frame LAN rack is designed to hold electronic equipment in communication data centers and telecommunication rooms.

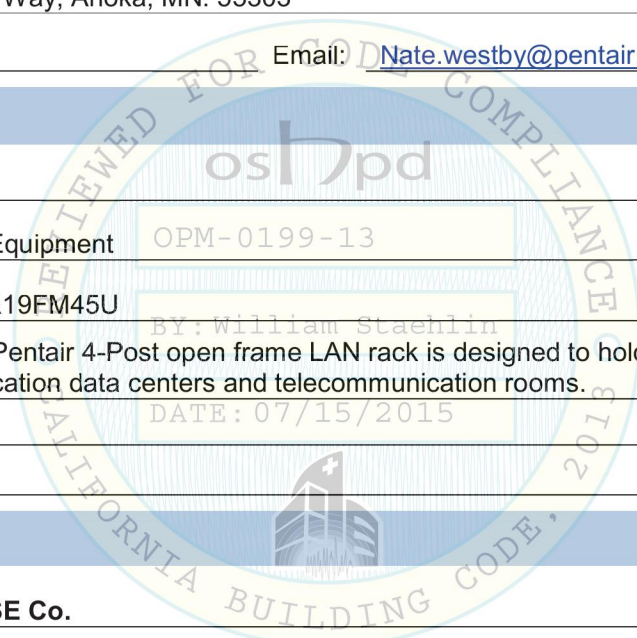

Applicant Information

Applicant Company Name: EASE Co.

Contact Person: Jonathan Roberson, S.E.

Mailing Address: 5877 Pine Ave. Suite 210, Chino Hills, CA. 91709

Telephone: (909) 606-7622 Email: J.Roberson@EASECo.com

I hereby agree to reimburse the Office of Statewide Health Planning and Development review fees in accordance with the California Administrative Code, 2013.

Signature of Applicant:  Date: 3/12/15

Title: Principal Engineer Company Name: EASE Co.

"Access to Safe, Quality Healthcare Environments that Meet California's Diverse and Dynamic Needs"

STATE OF CALIFORNIA – HEALTH AND HUMAN SERVICES AGENCY  
OSH-FD-700 (REV 1/24/13)



osHPD

Page 1 of 2





**OFFICE OF STATEWIDE HEALTH PLANNING AND DEVELOPMENT  
FACILITIES DEVELOPMENT DIVISION**

**Registered Design Professional Preparing Engineering Recommendations**

Company

Name: EASE Co.

Name: Jonathan Roberson, S.E.

California License Number: S4197

Mailing Address: 5877 Pine Ave. Suite 210, Chino Hills, CA. 91709

Telephone: 909-606-7667

Email: J.Roberson@EASECo.com

**OSHPD Special Seismic Certification Preapproval (OSP)**

Special Seismic Certification is preapproved under OSP-  
(Separate application for OSP is required)

Special Seismic Certification is not preapproved

**Certification Method(s)**

Testing in accordance with:  ICC-ES AC156  FM 1950-10

Other\* (Please Specify): \_\_\_\_\_

\*Use of test criteria other than those adopted by the California Building Standards Code, 2013 (CBSC 2013) for component supports and attachments are not permitted. For distribution system, interior partition wall, and suspended ceiling seismic bracings, test criteria other than those adopted in the CBSC 2013 may be used when approved by OSHPD prior to testing.

Analysis

Experience Data

Combination of Testing, Analysis, and/or Experience Data (Please Specify): \_\_\_\_\_

**List of Attachments Supporting the Manufacturer's Certification**

Test Report

Drawings

Calculations

Manufacturer's Catalog

Other(s) (Please Specify): \_\_\_\_\_

**OFFICE USE ONLY – OSHPD APPROVAL VALID FOR CBC 2013 ONLY**

Signature: *William Staehlin*

Date: 07-15-15

Print Name: William Staehlin

Title: SSE

Condition of Approval (if applicable): \_\_\_\_\_

"Access to Safe, Quality Healthcare Environments that Meet California's Diverse and Dynamic Needs"

STATE OF CALIFORNIA – HEALTH AND HUMAN SERVICES AGENCY  
OSH-FD-700 (REV 1/24/13)



osHPD

Page 2 of 2





**EQUIPMENT ANCHORAGE  
& SEISMIC ENGINEERING**

5877 Pine Ave, Ste. 210  
Chino Hills, CA. 91709  
Phn: (909) 606-7622

Office of Statewide Health Planning and Development  
**PREAPPROVAL OF MANUFACTURER'S CERTIFICATION**  
**OPM-0199-13**

**THIS PREAPPROVAL CONFORMS TO THE 2013 CALIFORNIA BUILDING CODE**

MANUFACTURER: **PENTAIR**  
EQUIPMENT NAME: **4-POST RACK**

Sheet: 1 of 9  
Date: 6/24/15

**GENERAL NOTES**

1. THIS OSHPD PREAPPROVAL OF MANUFACTURER'S CERTIFICATION (OPM) IS BASED ON THE 2013 CBC. THE DEMANDS (DESIGN FORCES) FOR USE WITH THIS OPM SHALL BE BASED ON THE 2013 CBC
2. THIS DOCUMENT MAY ONLY BE USED WITH THE EXPRESS WRITTEN CONSENT OF THE MANUFACTURER LISTED ABOVE FOR THE SPECIFIC PROJECT SITE AND INSTALLATION LOCATION. THIS DOCUMENT IS INVALID WITHOUT SUCH CONSENT.
3. THIS PREAPPROVAL CONFORMS TO THE 2013 CALIFORNIA BUILDING CODE WHERE  $S_{Ds}$  IS NOT GREATER THAN 1.50 & 2.20: SEE DETAILS FOR APPLICABILITY.
4. FORCES PER ASCE 7-10 SECTION 13.3.1, EQUATIONS 13.3-1, 13.3-2 & 13.3-3, WHERE  $S_{Ds} = 1.50$ ,  $a_p = 2.5$ ,  $I_p = 1.5$ ,  $R_p = 6.0$ ,  $z/h = 0$  AT CONCRETE SLAB. SEE FOLLOWING SHEETS FOR  $\Omega_o$ . WHERE  $S_{Ds} = 2.20$ ,  $a_p = 2.5$ ,  $I_p = 1.5$ ,  $R_p = 6.0$ ,  $z/h \leq 1$  AT CONCRETE SLAB ON METAL DECK. SEE FOLLOWING SHEETS FOR  $\Omega_o$ .
5. THIS PREAPPROVAL COVERS ONLY THE SUPPORTS AND ATTACHMENTS OF THE EQUIPMENT TO THE STRUCTURE.
6. ALL DESIGN FORCES SHOWN ON THE DRAWINGS ARE FACTORED LOADS THAT SHALL BE USED FOR STRENGTH DESIGN.
7. CONCRETE SLAB ON METAL DECK DETAIL VALID FOR DEMANDS SHOWN AT ANY ELEVATION IN THE BUILDING. (i.e.  $z/h \leq 1$ )
8. CONCRETE SLAB ON GRADE DETAIL VALID FOR DEMANDS SHOWN AT ANY ELEVATION BELOW GRADE. (i.e.  $z/h = 0$ )
9. **RESPONSIBILITIES OF THE STRUCTURAL ENGINEER OF RECORD OF THE BUILDING**
  - A. PROVIDE SUPPORTING STRUCTURE TO SUPPORT WEIGHTS AND FORCES SHOWN IN ADDITION TO ALL OTHER LOADS.
  - B. VERIFY THAT THE INSTALLATION IS IN CONFORMANCE WITH THE 2013 CBC AND WITH THE DETAILS, MATERIAL AND GAGE OF THE UNIT WHERE ATTACHMENTS ARE MADE AGREE WITH THE INFORMATION SHOWN ON THE PREAPPROVAL DOCUMENTS.
  - C. VERIFY THAT PROJECT SPECIFIC VALUES OF  $S_{Ds}$  &  $z/h$  RESULT IN SEISMIC FORCES ( $E_h$ ,  $E_v$ ) THAT DO NOT EXCEED THE VALUES ON THE DETAILS.
  - D. VERIFY THAT THE CONCRETE SLAB TO WHICH THE EQUIPMENT IS ANCHORED MEETS THE REQUIREMENTS OF THE APPLICABLE ICC ESR.
  - E. VERIFY THAT THE ANCHORS ARE AN ADEQUATE DISTANCE FROM ANY SLAB EDGES OR OPENINGS (SEE TYPICAL DETAIL ON SHEET 2).
  - F. VERIFY THAT ALL NEW OR EXISTING ANCHORS ARE AN ADEQUATE DISTANCE FROM THE UNIT ATTACHMENTS AND CHECK FOR INTERACTION WHERE OTHER ANCHORS ARE WITHIN 18" OR  $6h_{ef}$  FROM THIS UNIT'S ANCHORS.
  - G. EQUIPMENT MANUFACTURER MUST DESIGN UNIT TO MAKE C.G.  $\leq$  THAN THE C.G. HEIGHT DIMENSION SHOWN ON DRAWINGS.
  - H. ALL HOLES THRU STEEL FOR BOLTS SHALL BE STANDARD HOLE SIZE PER ANSI/AISC 360-10 TABLE J3.3.



## PENTAIR

## 4-POST RACK

DES. **J. ROBERSON**

JOB NO. **11-1461**

DATE **6/24/15**

SHEET

**2**

OF **9** SHEETS

### 10. EXPANSION ANCHORS:

- A. ATTACHMENT IS TO BE MADE WITH THE ANCHORS LISTED BELOW AND INSTALLED AS DESCRIBED IN THE CORRESPONDING ICC REPORT.

Anchor Diameter	Concrete Type	Min. f'c (psi)	Anchor Type	ICC Report No.	Min. Embed.	Min. Spacing	Min. Edge Dist.	Min. Conc. Thickness	Torque Test	Direct Tension
3/8"	Sand Light Weight	3000	Hilti Kwik Bolt TZ	ESR-1917	2"	N/A	N/A	See Sheet 8 of 9	25 FT-LB	1186 lb
5/8"	Normal Weight	3000	Hilti Kwik Bolt TZ	ESR-1917	3-1/8"	12"	24"	5"	60 FT-LB	3135 lb
5/8"	Normal Weight	3000	Hilti Kwik Bolt TZ	ESR-1917	4"	12"	24"	6"	60 FT-LB	4540 lb

1.) MAINTAIN FULL THREAD ENGAGEMENT FOR NUT & WASHER.

- B. THIS PREAPPROVAL ALLOWS FOR UP TO A MAXIMUM OF 2 ADJACENT CONCRETE SLAB EDGES, 24" AWAY MINIMUM (i.e. - CORNER). SEE ADJACENT DETAIL FOR ADDITIONAL MINIMUM ALLOWABLE CONCRETE EDGE DISTANCES.

- C. TESTING OF EXPANSION ANCHORS PER 2013 CBC, 1913A.7: TESTING SHALL BE DONE IN THE PRESENCE OF THE SPECIAL INSPECTOR AND A REPORT OF THE TEST RESULTS SHALL BE SUBMITTED TO OSHPD

- (i) AFTER AT LEAST 24 HOURS HAVE ELAPSED SINCE INSTALLATION, DIRECT PULL TENSION TEST OR TORQUE TEST AT LEAST 50% OF THE ANCHORS.

- (ii) ACCEPTANCE CRITERIA:

- DIRECT TENSION TEST: THE ANCHOR SHOULD HAVE NO OBSERVABLE MOVEMENT AT THE TEST LOAD. A PRACTICAL WAY TO DETERMINE OBSERVABLE MOVEMENT IS THAT THE WASHER BECOMES LOOSE.
- TORQUE TEST: THE APPLICABLE TORQUE MUST BE ACHIEVED WITHIN THE FOLLOWING LIMITS: WEDGE TYPE : 1/2 TURN OF THE NUT

- (iii) IF ANY ANCHOR FAILS, TEST ALL ANCHORS.

### 11. BOLTS THROUGH CONCRETE ON METAL DECK

- A. BOLTS SHALL BE TORQUED BY 3/4 TURN OF THE NUTS AFTER THE SNUG TIGHT (THE SNUG-TIGHT CONDITION IS DEFINED AS THE TIGHTNESS REQUIRED TO BRING THE CONNECTED PLIES INTO FIRM CONTACT) CONDITION IS ACHIEVED, UNLESS OTHERWISE NOTED.
- B. THROUGH BOLT HOLES SHALL BE 1/16" LARGER THAN BOLT SIZE (HOLE SIZE = BOLT SIZE + 1/16) FOR CONCRETE.
- C. THROUGH-BOLTS IN CONCRETE SHALL RECEIVE SPECIAL INSPECTION AND TESTING (THROUGH BOLTS WITH STEEL TO STEEL CONNECTION IN TENSION DO NOT REQUIRE TENSION TESTING) IN ACCORDANCE WITH REQUIREMENTS FOR POST-INSTALLED ANCHORS.

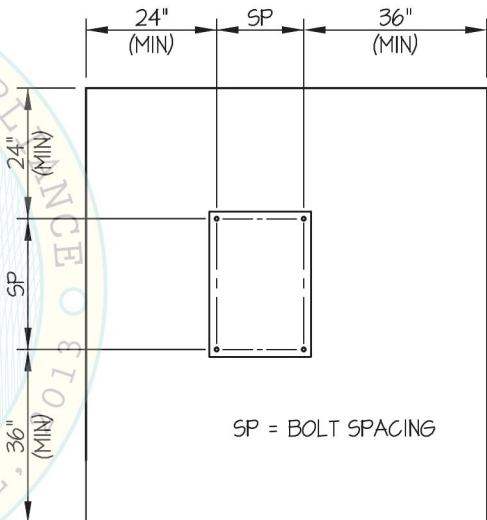

TYPICAL CONCRETE EDGE DETAIL

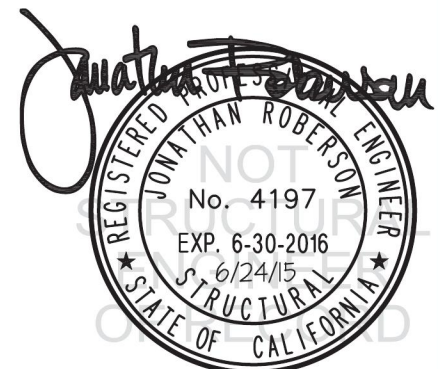

## PENTAIR 4-POST RACK

DES. **J. ROBERSON**

SHEET

**3**

JOB NO. **11-1461**

DATE **6/24/15**

OF **9** SHEETS

SEISMIC SUPPORTS & ATTACHMENTS

CONCRETE SLAB

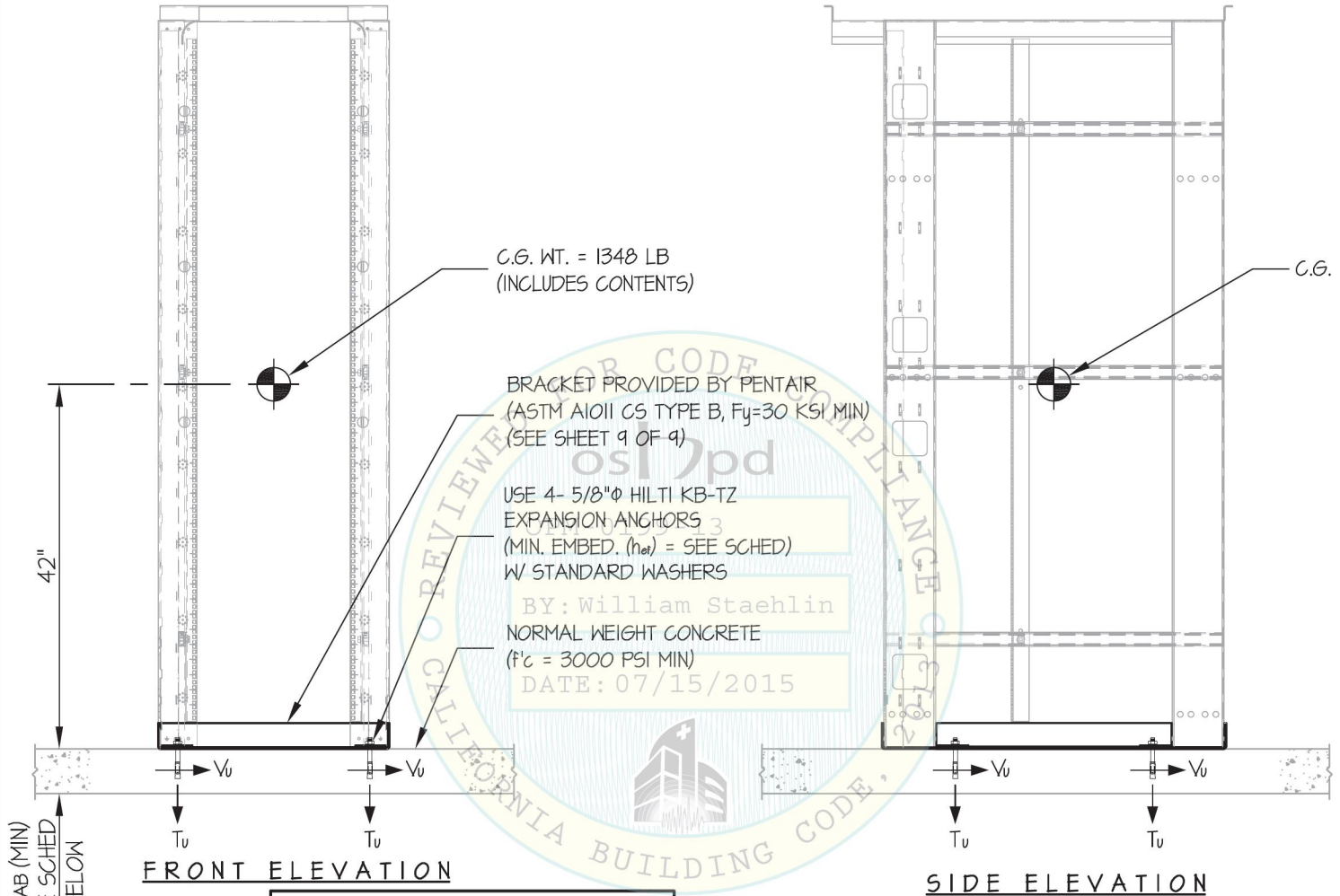

		ANCHORS						
MAX Sds	TYPE	DIAM	EFF EMBED	QTY	TSLAB	* Tu	* Vu	DETAIL
150	HILTI KB-TZ	5/8"	3.125"	4	5"	2208	570	SHEET 4 OF 9
220	HILTI KB-TZ	5/8"	4"	4	6"	3382	836	SHEET 5 OF 9

**NOTES:**

\* VALUES INCLUDE  $\Omega_o$

- FORCES ARE DETERMINED PER 2013 CALIFORNIA BUILDING CODE AND ASCE 7-10 STRENGTH DESIGN IS USED. ( $\alpha_p = 2.5, I_p = 1.5, R_p = 6.0, \Omega_o = 2.5, z/h = 0$ )
- CENTER OF GRAVITY (C.G.) AND WEIGHT ARE THE GOVERNING PARAMETERS FOR DESIGN. THIS PREAPPROVAL ENCOMPASSES ALL WEIGHTS UP TO THE MAXIMUM WEIGHT SHOWN.
- STRUCTURAL ENGINEER OF RECORD FOR THE BUILDING SHALL PROVIDE SUPPORT STRUCTURE DESIGNED TO SUPPORT WEIGHTS AND FORCES SHOWN IN COMBINATION WITH ALL OTHER LOADS THAT MAY BE PRESENT.
- SEE GENERAL NOTES: SHEETS 1 AND 2

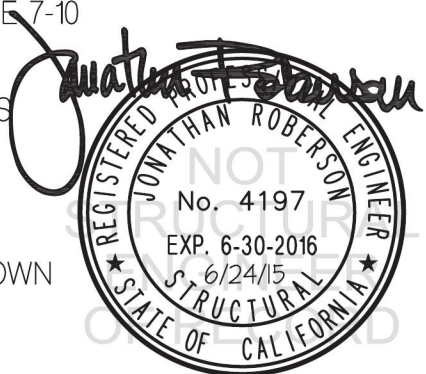

### PENTAIR

### 4-POST RACK

DES. **J. ROBERSON**

JOB NO. **11-1461**

DATE **6/24/15**

SHEET

# 4

OF **9** SHEETS

SEISMIC SUPPORTS & ATTACHMENTS

MAX Sds ≤ 1.50

CONCRETE SLAB

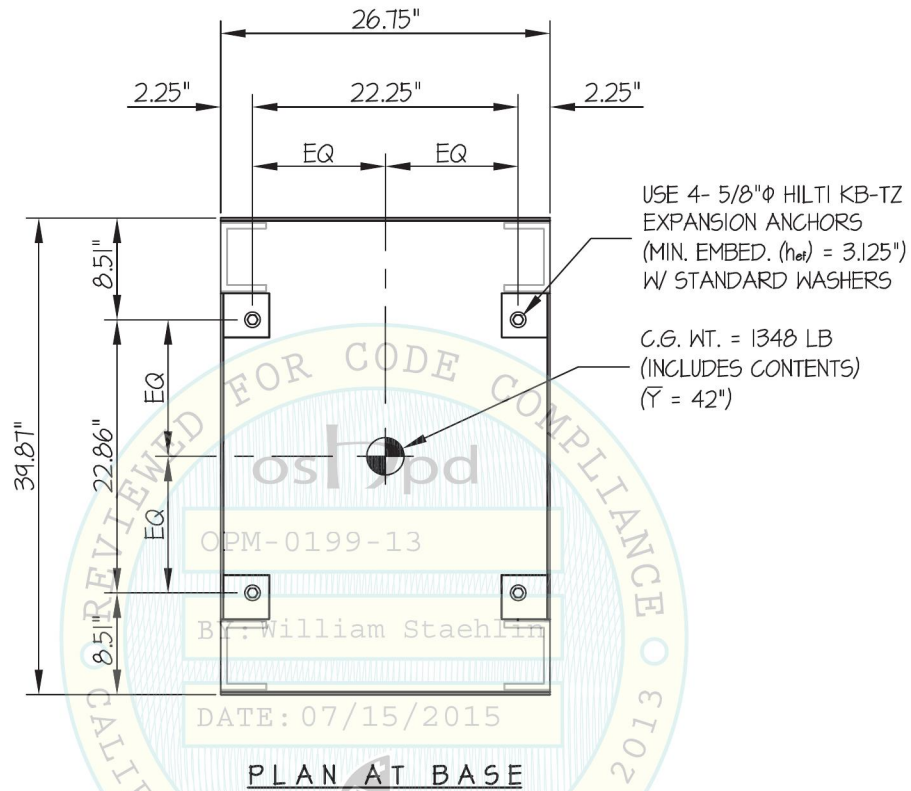

*Jonathan Roberson*

REGISTERED PROFESSIONAL ENGINEER  
JONATHAN ROBERSON  
No. 4197  
EXP. 6-30-2016  
6/24/15  
STRUCTURAL  
STATE OF CALIFORNIA

### PENTAIR

### 4-POST RACK

DES. **J. ROBERSON**

JOB NO. **11-1461**

DATE **6/24/15**

SHEET

# 5

OF **9** SHEETS

SEISMIC SUPPORTS & ATTACHMENTS

1.50 < MAX Sps ≤ 2.20

CONCRETE SLAB

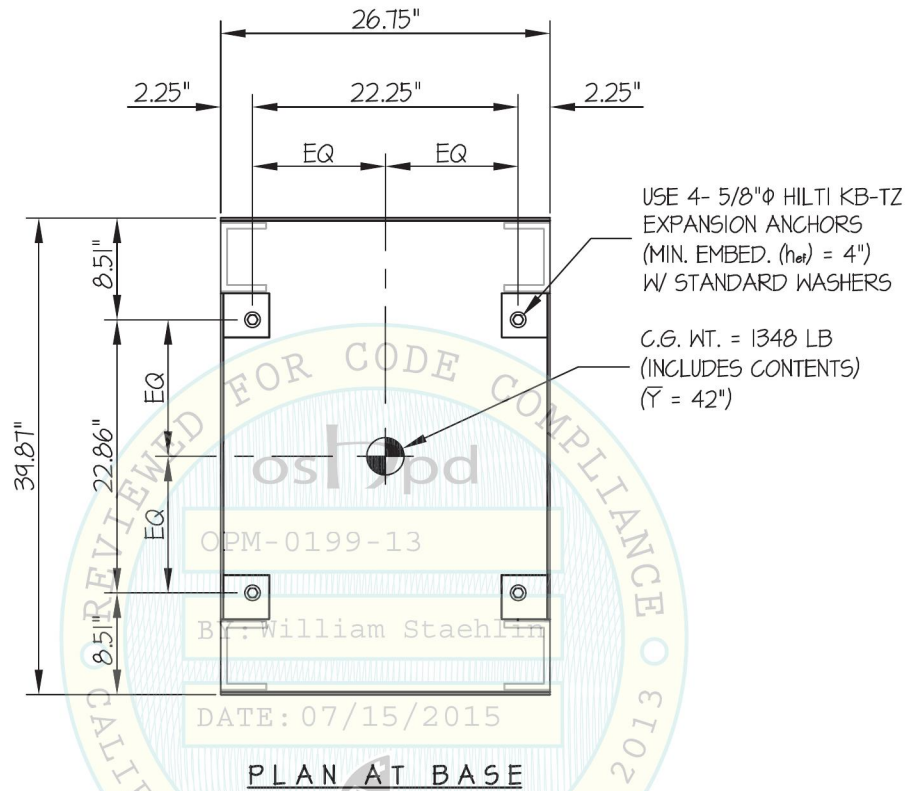

## PENTAIR 4-POST RACK

DES. **J. ROBERSON**

SHEET

**6**

JOB NO. **11-1461**

DATE **6/24/15**

OF **9** SHEETS

**SEISMIC SUPPORTS & ATTACHMENTS**

**CONCRETE SLAB ON METAL DECK**

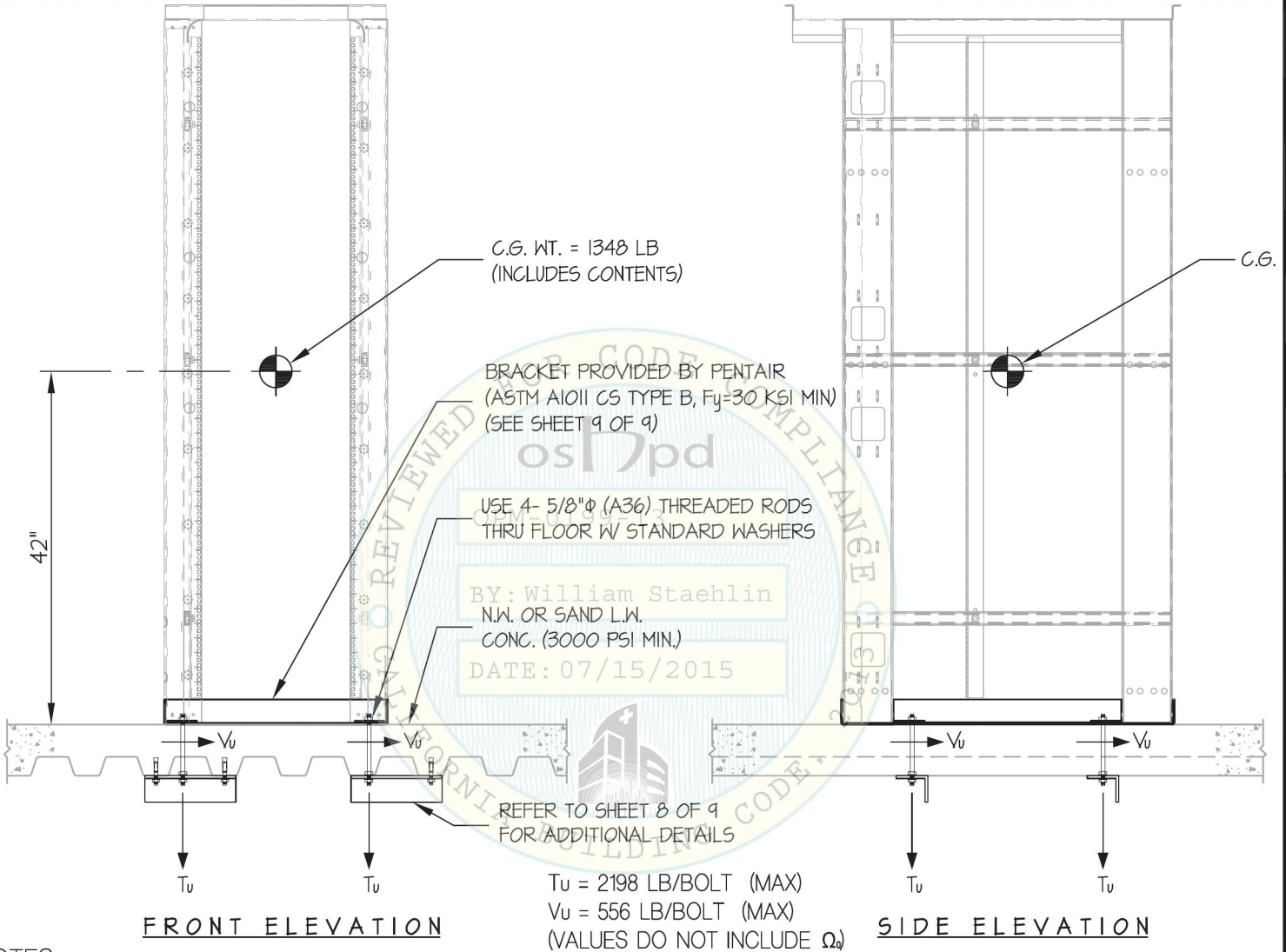

**NOTES:**

- FORCES ARE DETERMINED PER 2013 CALIFORNIA BUILDING CODE AND ASCE 7-10 STRENGTH DESIGN IS USED. ( $S_{ds} = 2.20$ ,  $a_p = 2.5$ ,  $I_p = 1.5$ ,  $R_p = 6.0$ ,  $\Omega_o = 2.5$ ,  $z/h \leq 1$ )  
HORIZONTAL FORCE ( $E_h$ ) =  $1.65 W_p$   
HORIZONTAL FORCE ( $E_{mh}$ ) =  $4.13 W_p$  (FOR CONCRETE ANCHORAGE)  
VERTICAL FORCE ( $E_v$ ) =  $0.44 W_p$
- CENTER OF GRAVITY (C.G.) AND WEIGHT ARE THE GOVERNING PARAMETERS FOR DESIGN. THIS PREAPPROVAL ENCOMPASSES ALL WEIGHTS UP TO THE MAXIMUM WEIGHT SHOWN.
- STRUCTURAL ENGINEER OF RECORD FOR THE BUILDING SHALL PROVIDE SUPPORT STRUCTURE DESIGNED TO SUPPORT WEIGHTS AND FORCES SHOWN IN COMBINATION WITH ALL OTHER LOADS THAT MAY BE PRESENT.
- SEE GENERAL NOTES: SHEETS 1 AND 2

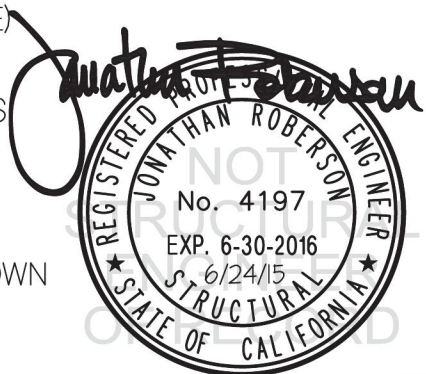



## PENTAIR 4-POST RACK

DES. **J. ROBERSON**

SHEET

**7**

JOB NO. **11-1461**

DATE **6/24/15**

OF **9** SHEETS

SEISMIC SUPPORTS & ATTACHMENTS

CONCRETE SLAB ON METAL DECK

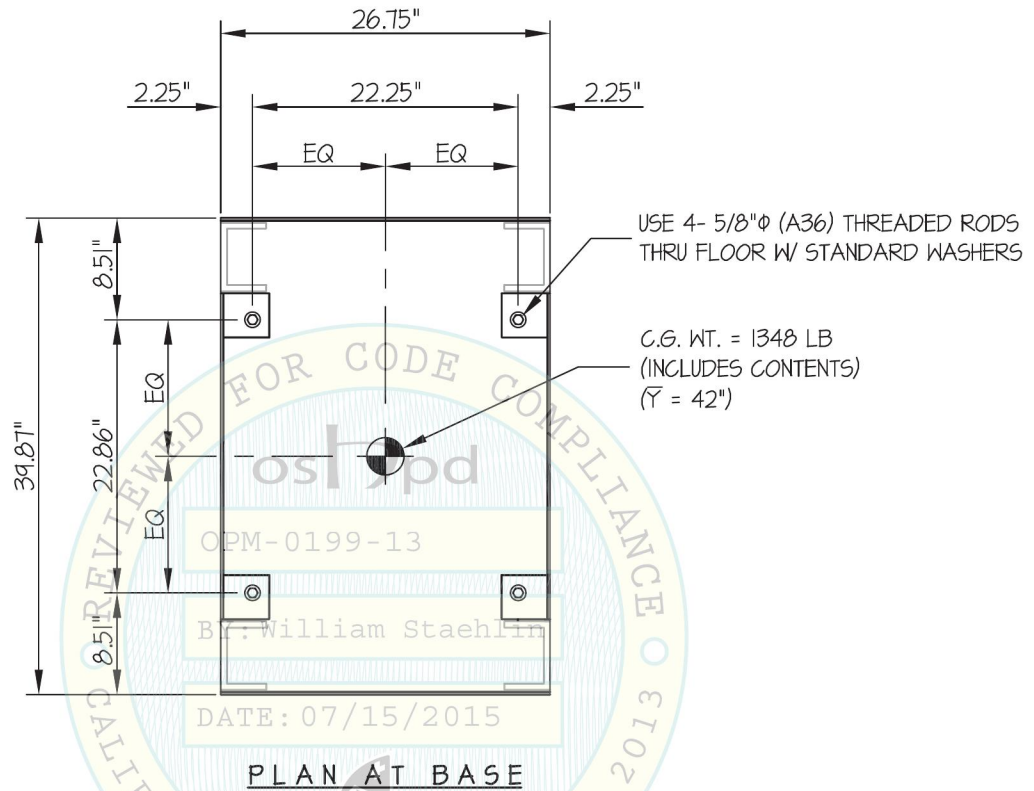

## PENTAIR

## 4-POST RACK

DES. **J. ROBERSON**

JOB NO. **11-1461**

DATE **6/24/15**

SHEET

**8**

OF **9** SHEETS

SEISMIC SUPPORTS & ATTACHMENTS

CONCRETE DETAILS

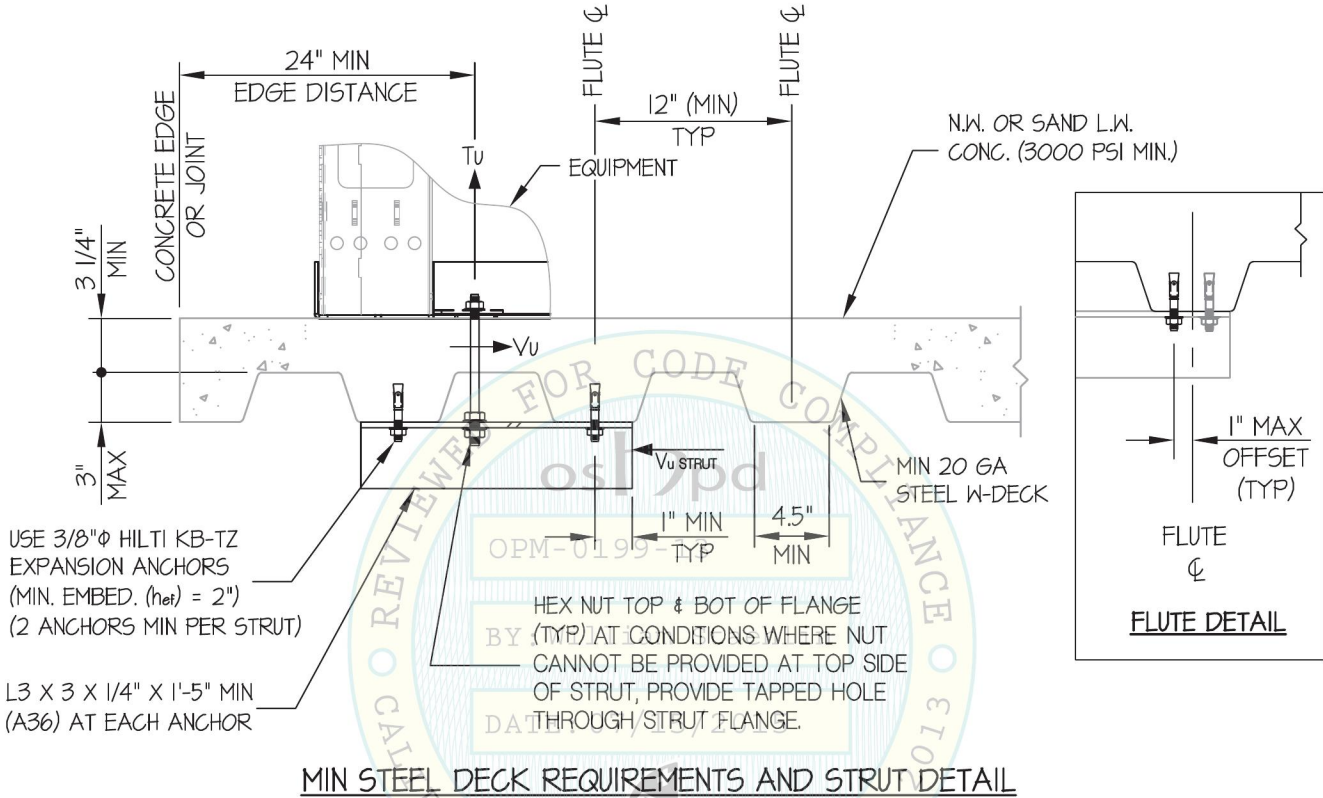

*Jonathan Roberson*

REGISTERED PROFESSIONAL ENGINEER  
JONATHAN ROBERSON  
No. 4197  
EXP. 6-30-2016  
6/24/15  
STRUCTURAL  
STATE OF CALIFORNIA

## PENTAIR

## 4-POST RACK

DES. **J. ROBERSON**

JOB NO. **11-1461**

DATE **6/24/15**

SHEET

**9**

OF **9** SHEETS

SEISMIC SUPPORTS & ATTACHMENTS

BRACKET DETAILS

BRACKET PROVIDED BY PENTAIR  
(ASTM A1011 CS TYPE B, F<sub>y</sub>=30 KSI MIN)

4"X4"X1/4" THK (A36) MOUNTING PLATE  
(PROVIDED BY PENTAIR)  
(4 PLACES)

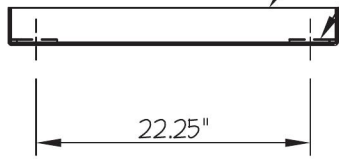

ELEVATION

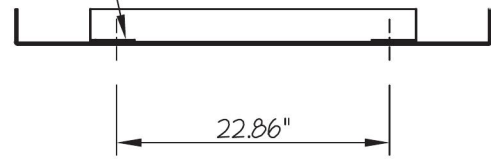

SIDE

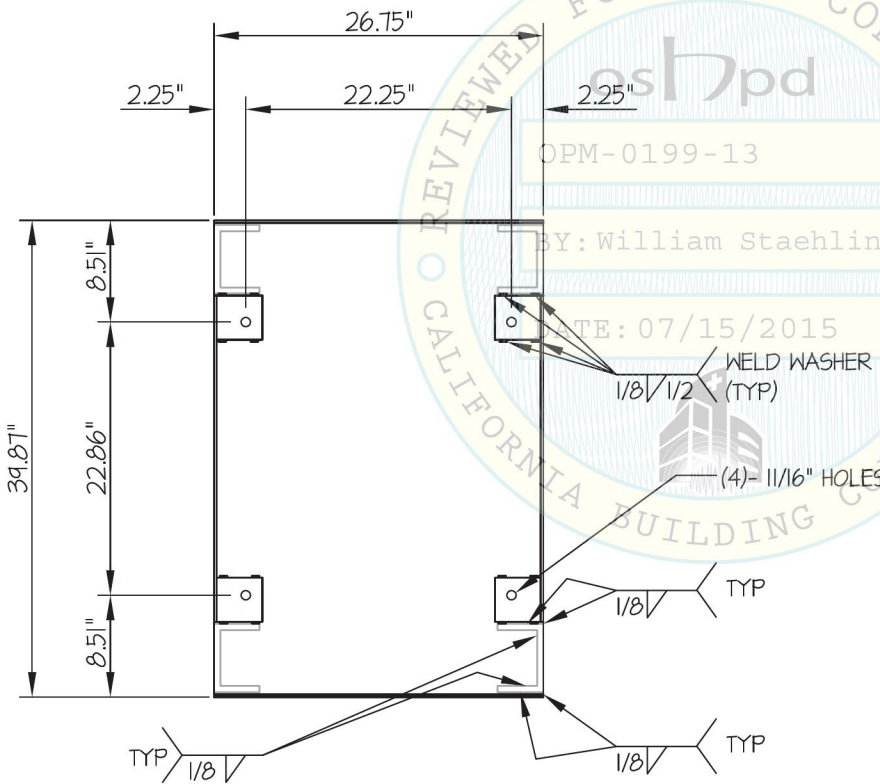

PLAN

